



CANARM - HOLLYN LED - CEILING FAN INSTALLATION GUIDE

5 YEAR LIMITED WARRANTY

"Thank you" for purchasing our product. It is our policy to furnish you with high quality products at a fair price. With proper installation your fan should provide you with years of money saving comfort.

This fan is guaranteed to be free from defects in workmanship and Material for a period of five (5) years from date of purchase. Within the first (1) year from date of purchase any defective product should be returned to your **RETAIL OUTLET** along with proof of purchase. For the balance of the warranty, four (4) years, the **MOTOR WINDINGS ONLY** shall be free of defects. We will correct such defects or replace the motor assembly at our option if the product is returned, **FREIGHT PREPAID**, to us. The returned fan must be accompanied by your proof of purchase and a cheque for \$20.00 for handling and labour charges. All costs of removing and re-installing the product are **YOUR RESPONSIBILITY** damage to any part as such by accident, misuse, improper installation or by affixing any accessories **IS NOT** covered by this warranty. As a result of varying climatic conditions in our area this warranty does not cover any changes in finishes, including rusting, pitting, corroding, tarnishing or peeling.

WARRANTY VOID: In cases of alteration, abuse, installation not in accordance with instructions or REMOVAL of the CSA Sticker.

11/16

CF-24
LED
01/20



Questions or Concerns Contact At The Following Numbers Before Returning Product To The Store:

1-800-265-1833 (English) / 1-800-567-2513 (French)
Monday through Friday 8:00 AM to 5:00 PM E.S.T.

INSTALLATION INSTRUCTIONS

DOWNROD MOUNT SERIES

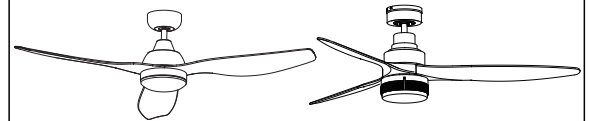

"INSTRUCTIONS PERTAINING TO RISK OF FIRE OR INJURY TO PERSONS"
"READ ALL INSTRUCTIONS"

"IMPORTANT SAFETY INSTRUCTIONS"
"SAVE THESE INSTRUCTIONS"

INSTALLATION AND WIRING TO BE IN ACCORDANCE WITH CEC, NEC, LOCAL ELECTRICAL CODES and ANSI/NFPA 70.
Consult a qualified electrician if you are not familiar with wiring.

TOOLS AND MATERIALS REQUIRED

- Philips Screw Driver
- Blade Screw Driver
- Step Ladder
- Wire Cutters
- Wiring supplies as required by electrical code.

NOTE: FOR OPTIMUM QUIETNESS, FULLY ASSEMBLE FAN AND RUN 24 HOURS

2157 Parkedale Ave.,
Brockville, Ontario
K6V 5V6
PH: (613) 342-5424
FX: (613) 342-8437

2555 Rue Bernard
Lefebvre Laval, Quebec
H7C 0A5
PH: (450) 665-2535
FX: (450) 665-0910



#2 Chootoo Road, South Aranguéz, San Juan, Trinidad





CANARM - HOLLYN LED - CEILING FAN INSTALLATION GUIDE

SAFETY PRECAUTIONS

1. Turn off power at main electrical service box before starting installation.
2. Electrical connections must comply with local code ordinances, national electrical codes, CEC, NEC and ANSI/NFPA 70.
3. Make sure the installation site you choose allows the fan blades to rotate freely without any obstructions.
4. When mounting the fan on a ceiling outlet box, Use an approved (CSA for Canada and UL for U.S.) ceiling fan box marked **"FOR FAN SUPPORT"**. Ensure the outlet box is securely installed in place such that it is able to support at least the fan weight.
5. **WARNING:** To reduce the risk of fire, electric shock, or personal injury, mount fan only to an outlet box marked acceptable for fan support and use mounting screws provided with the outlet box. Most outlet boxes commonly used for the support of lighting fixtures are not acceptable for fan support and may need to be replaced. Consult a qualified electrician if in doubt.
6. Total Fan Weight For Reference: 52" approximate 4.8 kgs(10.58 lbs).

WARNING

- **WARNING:** TO REDUCE THE RISK OF FIRE, ELECTRIC SHOCK, OR PERSONAL INJURY, MOUNT TO OUTLET BOX MARKED ACCEPTABLE FOR FAN SUPPORT AND USE MOUNTING SCREWS PROVIDED WITH THE OUTLET BOX.
- Mount with the lowest moving parts at least 2.10 Meters (7 Feet) above floor or grade level.
- **DO NOT** operate reversing switch while fan blades are in motion. Fan must be turned off and rotating blades stopped, reverse chain pulled, the speed chain pulled again to start in the opposite direction.

REMOTE CONTROL

- ① LED indicated light
- ② ON/OFF the fan
- ③ Speed of the fan (①low speed — ⑤high speed)
- ④ Timing control of the fan
- ⑤ Short press: ON/OFF the light
- ⑥ Direction of the fan (reverse switch)
- ⑦ Long press/hold for 3 seconds: Dimming
- ⑧ A Pair of NO.7 battery of emitter (1.5V)

Pg. #2

Supplier's Declaration of Conformity 47 CFR § 2.1077 Compliance Information

Unique Identifier: CANARMNA
 Responsible Party
 CanarmInc.
 808 Commerce Park Drive, Ogdensburg, New York, USA 13669
 1-800-267-4427

This equipment has been tested and found to comply with the limits for a Class B digital device, pursuant to Part 15 of the FCC Rules. These limits are designed to provide reasonable protection against harmful interference in a residential installation. This equipment generates, uses and can radiate radio frequency energy and, if not installed and used in accordance with the instructions, may cause harmful interference to radio communications. However, there is no guarantee that interference will not occur in a particular installation. If this equipment does cause harmful interference to radio or television reception, which can be determined by turning the equipment off and on, the user is encouraged to try to correct the interference by one or more of the following measures:

- Reorient or relocate the receiving antenna.
- Increase the separation between the equipment and receiver.
- Connect the equipment into an outlet on a circuit different from that to which the receiver is connected.
- Consult the dealer or an experienced radio/TV technician for help.

CAUTION:

Any changes or modifications not expressly approved by the grantee of this device could void the user's authority to operate the equipment. This device complies with Part 15 of the FCC Rules. Operation is subject to the following two conditions: (1) This device may not cause harmful interference, and (2) this device must accept any interference received, including interference that may cause undesired operation.

This device contains licence-exempt transmitter(s)/receiver(s) that comply with Innovation, Science and Economic Development Canada's licence-exempt RSS(s). Operation is subject to the following two conditions:

1. This device may not cause interference.
2. This device must accept any interference, including interference that may cause undesired operation of the device.

FCC:BTR66.181.19.0001.35
 ICES-005:BTR66.181.19.0001.35-1

Pg. #11



CANARM - HOLLYN LED - CEILING FAN INSTALLATION GUIDE

7. LIGHT KITS

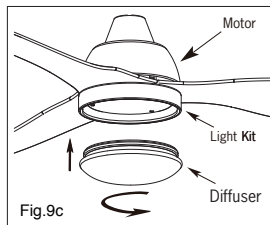

WARNING: Ensure that all connections, set screws and screws are securely tightened before the next step.

To clean the fixture, turn off the power, wait for it to cool, and wipe the fixture with a clean, soft cloth.

TROUBLESHOOTING SUGGESTIONS

- | TROUBLE | SUGGESTIONS |
|---------------------------------------|--|
| 1. Fan will not start | <ul style="list-style-type: none"> - Check fuses and circuit breakers. - Check wiring connections to fans. - Check wiring connections in switch housing. <p>CAUTION: Turn power off for last two items.</p> |
| 2. Fan sounds noisy | <ul style="list-style-type: none"> - Check to make sure that all screws in motor housing are snug. - Check to make sure that blade bracket screws are tight. - Check to make sure that wire nuts in switch housing are not rattling against wall of switch housing. - If fan has a light kit make sure switch housing screws and set screws are tight. - Some fan motors are sensitive to signals from solid state variable controls. If solid state controller is used, change to an alternative control. (See a representative for a list of available controls.) - Allow a 24 hour break in period to eliminate most noises. |
| 3. Fan wobbles or shakes excessively. | <ul style="list-style-type: none"> - Check that all blades are screwed firmly into blade brackets. - Check that blade brackets are secured firmly to motor. - Check distance from tip of blades to ceiling. - Check distance between blade tip to blade tip. All measurements should be equal. Loosen blade screws and position blade until even then re-tighten. - Check that the downrod hemisphere notch is engaged in canopy. - Check to make sure that jam screws in downrod are tightened. - Make sure canopy and mounting bracket are tightened securely to wooden joist. - Make sure warpage has not occurred in Fan blades. If so, contact the customer service department for replacement parts. |

Pg. #10

ASSEMBLY DRAWING

- A. Mounting Bracket
- B. Canopy
- C. Downrod Assembly
- D. Yoke Cover
- E. Fan Motor Assembly
- F. Light Kit
- G. Glass Panel
- H. Diffuser
- I. Remote Control
- J. Fan Blade

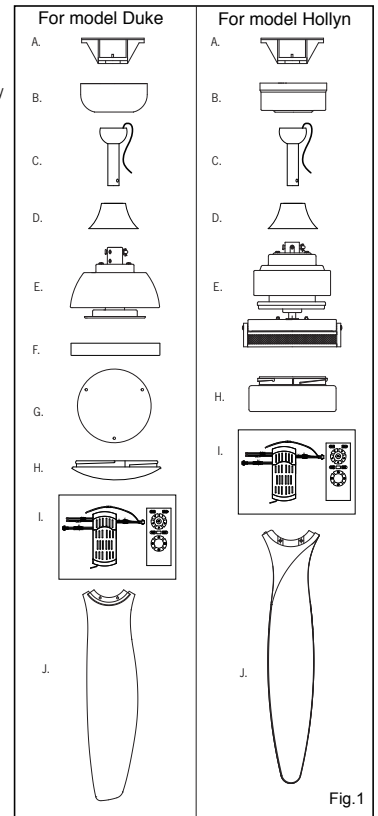

Fig.1

Pg. #3

CANARM - HOLLYN LED - CEILING FAN INSTALLATION GUIDE

1. ATTACH THE FAN BLADES

- Remove the cover on the top housing.

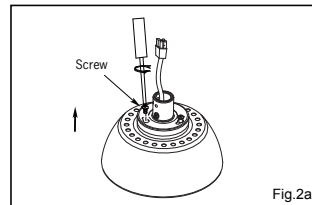

- Attach the blades to the fan motor assembly using the Blade Bracket Screws, Metal Washer and Lock Washer. Slightly turn the blade after installation and repeat the same step for the other blades.

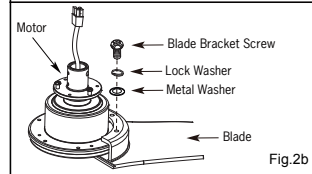
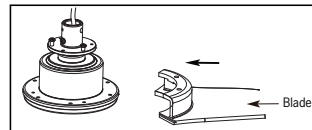

- Re-attach the cover to the top housing.

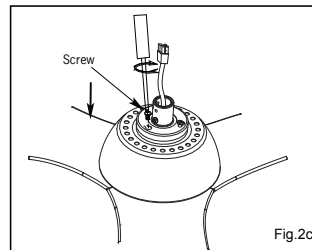

INSTALLATION

NOTE: All set screws must be checked and retightened where necessary, before and after installation.

Pg. #4

6. ENGAGE HEMISPHERE (Downrod Mount Only)

- Carefully rotate fan assembly until groove in hemisphere locks over tab of canopy assembly.

WARNING: Failure to seat tab in groove could cause damage to electrical wires and possible shock or fire hazard.

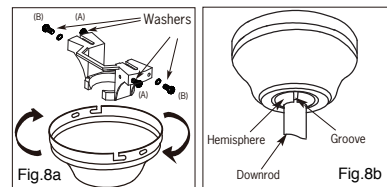

NOTE: When installing fan on sloped ceiling, make sure tab on hanger bracket faces towards the top of the slope. Depending on the slope, a longer downrod may be required to prevent fan blades from hitting the ceiling.

7. LIGHT KITS

DETACHABLE LIGHT KITS (Refer to one of the following light kits for your model)

- Remove light kit screws and washers.
- Connect polarized connectors of light kit to corresponding connectors found in switch housing.

WARNING: BE SURE TO TURN OFF POWER BEFORE INSTALLING

Connect polarized connectors of light kit to corresponding connectors found in switch housing.
- Install the light kit to the fan motor assembly by tightening 3 screws.
- Remove the 3 plastic screw from light kit.
- Install the glass panel on the light kit by tightening the 3 plastic screws.
- Screw the diffuser to the Light kit.

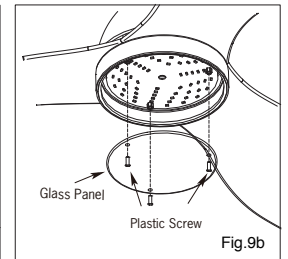
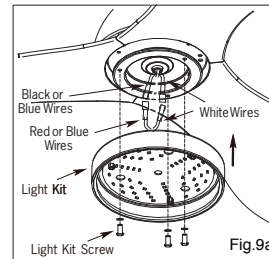

Pg. #9

CANARM - HOLLYN LED - CEILING FAN INSTALLATION GUIDE

4. ELECTRICAL HOOK-UP

FUNCTION INSTRUCTION OF EMITTER

- Learning code and matching mode is used between transmitter and receiver.
- Turn "ON" the supply power. Within 30 seconds, press "FAN ON/OFF" button on the transmitter for 5 seconds. Transmitter and receiver are connected after hearing a long "beep".
- If the transmitter cannot control the fan, check to ensure all wiring connections are properly connected according to the instruction manual. Check to ensure the batteries are in the right position. Check whether there are any similar remote controls in use nearby. Check whether they work with the same frequency.
- Low voltage of battery will affect the sensitivity of the transmitter. The indicator light will flash when battery voltage is low. Replace the batteries for better performance.
- Take out the batteries from the transmitter when leaving unused for long periods of time.
- **Ensure to connect the ground wire accordingly.**

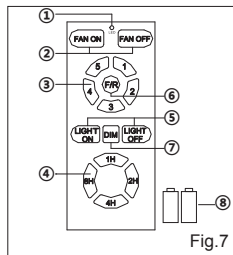

2. MOUNTING OPTION

DOWNROD MOUNT

- Remove cotter pin and bolt from yoke.
- Loosen jam screw in yoke until it is flush with the inside surface.
- Obtain downrod, canopy and yoke cover.
- Place downrod inside canopy and yoke cover.
- Route wires exiting motor through yoke cover, canopy and downrod.
- Insert bolt through hole in shaft and downrod. **Be careful not to damage or cut the fan wires.**
- Tighten flat washer and bolt. Secure with cotter pin through hole in the end of the bolt.
- Secure downrod in position by tightening jam screws. Slide yoke cover down so it is flush with the motor housing.

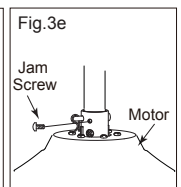
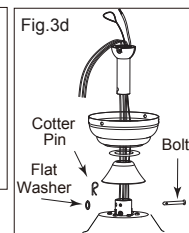
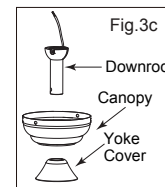
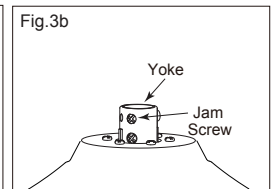
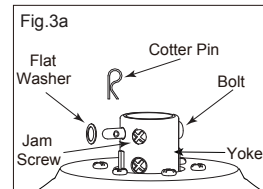

5. MOUNTING FAN ASSEMBLY

- Place two screws and washers on mounting bracket (marked B on diagram) which correspond with slots in canopy. Screw in two turns.
- Position canopy to mounting bracket aligning slots to screws (marked B on diagram) then turn to lock.
- Position and tighten the two screws and washers (marked A on diagram) then tighten the two screws (marked B on diagram).

CANARM - HOLLYN LED - CEILING FAN INSTALLATION GUIDE

3. INSTALL MOUNTING BRACKET

WARNING: To Reduce The Risk Of Fire, Electric Shock, Or Personal Injury, Mount To UL/CSA Listed Outlet Box Marked Acceptable for Fan Support And Use Mounting Screws Provided With The Outlet Box.

- Install J-Hook through centre of outlet box and into the wooden joist.
- Secure mounting bracket and rubber gaskets to outlet box.
- Hang the safety cable onto the J-hook.
- Hang fan on temporary hook or mounting bracket.

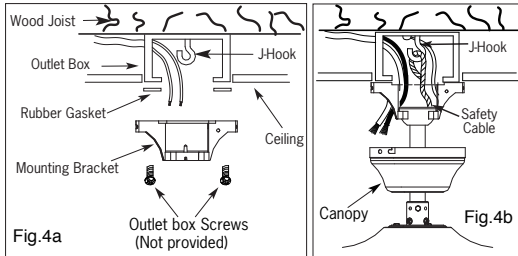

Fig. 4a
Outlet box Screws (Not provided)

Fig. 4b

4. ELECTRICAL HOOK-UP

- A**
- Make the following wire connections to the receiver unit (see fig. 5) using the wire nuts supplied.
 - Connect GREEN fan wire to BARE (ground) wire.
 - Connect BLACK receiver unit wire to BLACK supply wire.
 - Connect WHITE receiver unit wire to WHITE supply wire.
 - After making the wire connections, ensure the wires should be spread apart with the grounded conductor and the equipment-grounding conductor on one side of the outlet box and the ungrounded conductor on the other side of the outlet box.
 - Ensure the splices after being made should be turned upward and pushed carefully up into the outlet box.
 - Connect the 4-Wire female and male plug.
 - Connect the 2-Wire female and male plug.

Pg. #6

4. ELECTRICAL HOOK-UP

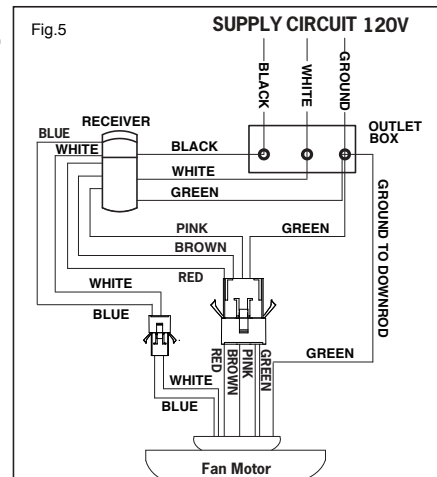

In Quebec, the installation of this product must be carried out by a qualified electrician.

NOTE: Once ground wires are connected, carefully tuck all wires and wire nuts into the metal outlet box making sure that the wires are clear of the hemisphere and downrod when positioned in mounting bracket.

- Push all connected wires up into ceiling box.
- Position the receiver into the canopy as shown direction.

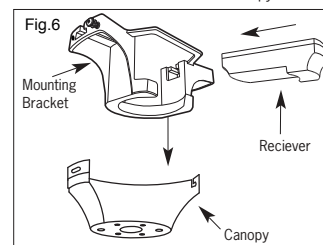

- When installing the canopy, ensure the antenna is not pressed by the canopy.

Pg. #7